

Chromalox®

Installation Instructions and RENEWAL PARTS IDENTIFICATION

SERVICE REFERENCE

DIVISION 4		SECTION AR	
SALES REFERENCE (Supersedes PK405-17)		PK405-18	
161-049287-001			
DATE		MARCH, 2004	

AR (Single Phase) Industrial Thermostat

Table A – Specifications

NEMA I Model*	Temperature Range (°F)	Sensing Bulb			Capillary Length (Ft.)	Maximum A.C. Rating (Amps.)
		Style	Dia. (In.)	Approx. Length (In.)		
AR-115	0–100°F	5	0.375	4-3/8	7	10 Amp. 480 Vac 30 Amp. 120-277 Vac 250VA 120-277 Vac (Pilot Duty)
AR-115A					2	
AR-115C					12	
AR-214	60–250°F	4	0.250	5-5/32	7	
AR-214D					15	
AR-215		5	0.375	4	7	
AR-215A					2	
AR-219		9	0.188	10-3/4	7	
AR-219D					15	
AR-514	200–550°F	4	0.250	7-5/16	7	
AR-515		5	0.375	3-5/8	7	
AR-515A					2	
AR-519		9	0.188	11-1/2	7	
AR-519D					15	
AR-715	300–700°F	5	0.375	3-11/16	7	
AR-715D					15	
AR-719					9	0.188

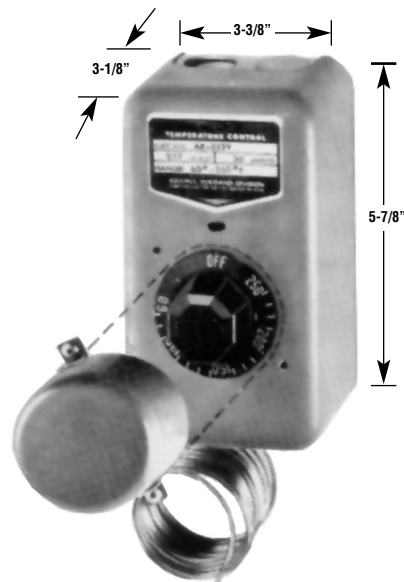

NEMA-I Model

*Models equipped with Pilot Light are designated by the suffix "P" on the Model Number.
Models equipped with Knob Cover are designated by the suffix "KC" on the Model Number.
Models equipped with both a Pilot Light and a Knob Cover are designated by the suffix "PKC" on the Model Number.
Models installed in a moisture resistant enclosure are designated by the suffix "LT" on the Model Number.
Pilot Light nor Knob Cover available on LT models.

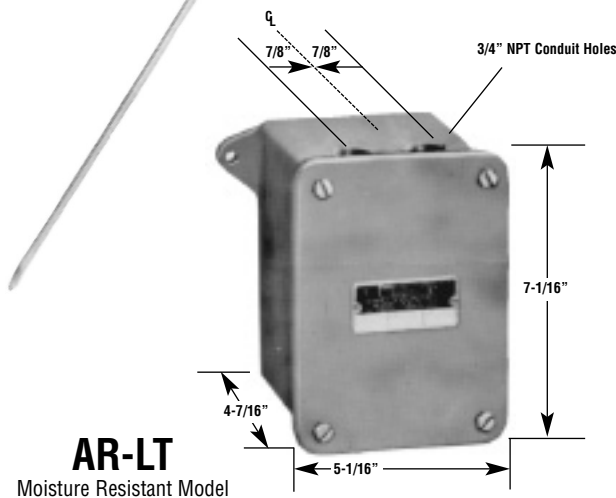

AR-LT
Moisture Resistant Model

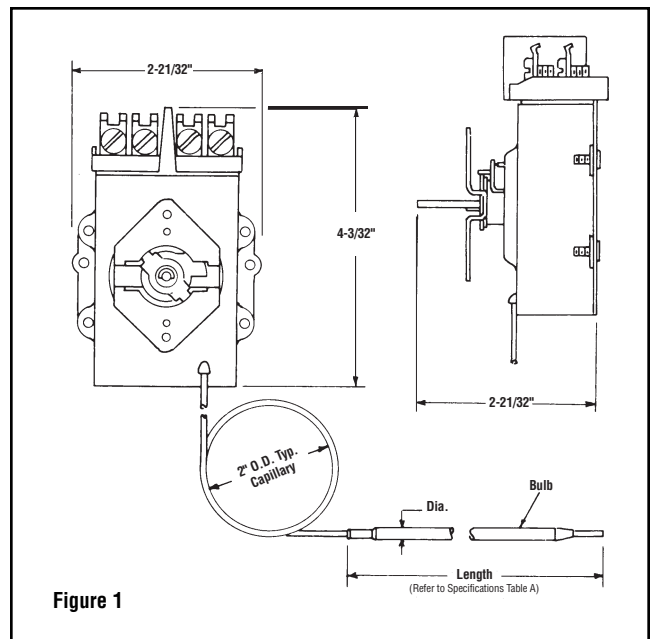

Figure 1
(Refer to Specifications Table A)

GENERAL

NOTICE: Type AR Thermostats are designed for temperature control service only. Because they do not fail safe, they should not be used for temperature limiting duty.

⚠ WARNING

The system designer is responsible for the safety of this equipment and should install adequate back-up controls and safety devices with their electric heating equipment. Where the consequences of failure could result in personal injury or property damage, back-up controls are essential.

Principle of Operation – Control action of these thermostats is provided through the principle of liquid volume change. With a variation in temperature, the liquid in the sensing bulb expands or contracts, causing a bellows to actuate the switching mechanism.

Enclosure – The control enclosure and cover assembly is of heavy-gauge electrical grade plastic on NEMA-I models.

Moisture resistant (LT) models have enclosure and cover assembly made of heavy gauge cast aluminum.

Power Supply –

⚠ WARNING

FIRE/ELECTRIC SHOCK HAZARD. Use AC supply only. Thermostat is not DC rated.

Control Range – The following temperature ranges are available:

0° to 100°F	200° to 550°F
60° to 250°F	300° to 700°F

Process Temperature Differential – is variation in controlled process temperature between maximum, when thermostat turns OFF and minimum, when thermostat turns ON. This spread in temperature may be minimized by:

1. Making sure control is mounted to vertical surface (see Step 1, Mounting section).
2. Avoiding excess heating capacity (oversized heaters).
3. Locating control sensing bulb in optimum position between heat source and work.

In general, it is difficult to predict the actual operating differential of a given process. Temperature differential may be as low as 4°F for low range controls to as high as 17°F for higher range controls since the differential is a percentage function of the dial range.

Packing Glands – If a sealed or leak-proof connection is required at the point where the capillary enters the oven, tank, pipe or similar equipment, an appropriate packing gland is available as an optional part. (Model Numbers CCF-25A, CCF-25D or CCF-25E).

⚠ WARNING

FIRE/EXPLOSION HAZARD. This thermostat is not intended for use in hazardous atmospheres where flammable vapors, gases, liquids or other combustible atmospheres are present as defined in the National Electrical Code. Failure to comply can result in personal injury or property damage.

MOUNTING

Note: Do not mount control where it will be subject to vibration, shock, grease, dust, lint or corrosive vapors. Do not mount adjacent to a large magnetic contactor, as vibration and shock will cause thermostat to interact erratically - resulting in chattering of the contactor.

The air temperature in and around the control enclosure should be kept as near to normal room temperature as possible...**never** above 150°F.

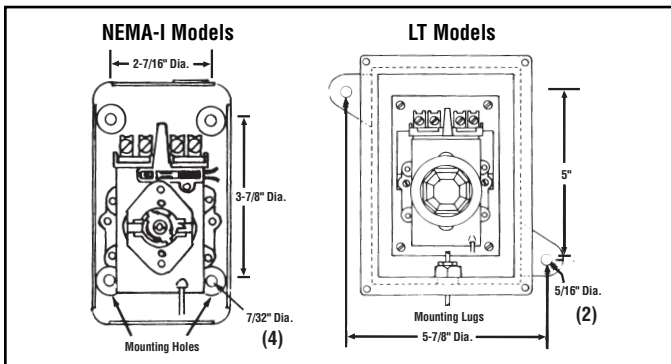

1. To facilitate adjusting and reading the thermostat, knob setting must be mounted in a vertical position only.
2. Use sheet metal or wood screws through the mounting holes in baseplate to mount control (see Figure 2).
3. For controlling platen or die temperatures, insert entire sensing bulb into drilled holes selected for snug slip fit.

The longer, more sensitive Style 9 bulbs should be used for controlling air temperatures or pipe line heating.

Note: If material in contact with bulb or capillary is corrosive, a protective well should be used. Protective wells are available as an optional part. Check factory.

4. CAUTION –

- A. Bending or deforming sensing bulb will alter control calibration – requiring recalibration after installation. See CALIBRATION section, page 3. If necessary, Style 9 bulbs can be coiled to 1" I.D. (see Figure 3).
- B. Do not kink capillary tube. The resulting constrictions in fluid flow can destroy control function or broaden temperature differential. Minimum capillary tube bending diameter is 1/2" I.D. (see Figure 4).

Figure 3
(Sensing Bulb)

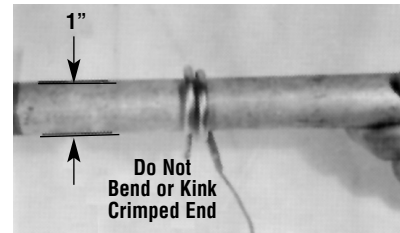
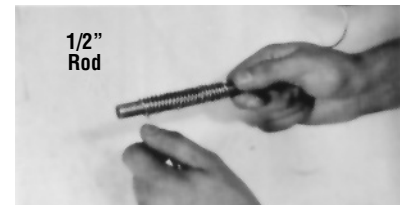

Figure 4
(Capillary Tube)



- C. Any deformations of bulb or capillary that result in leakage of fluid from control renders control inoperative.
- D. Avoid passing control capillary tube through zones whose temperature is in excess of controlled process temperature. Erratic control or destruction of control function may result.

WIRING

⚠ WARNING

ELECTRIC SHOCK HAZARD. Disconnect all power to heater before installing or servicing thermostat. Failure to do so could result in personal injury or property damage. Thermostat must be installed by a qualified person in accordance with the National Electrical Code, NFPA 70.

1. Electrical wiring must be installed in accordance with National Electrical Codes or local codes.

CAUTION: Use copper conductors only.

NEMA-I Models –

- A. Entrance for wiring is provided by two 1/2" conduit holes in end of base plate.
- B. If control is a "–KC" model (knob cover), remove knob cover as in Figure 5.
- C. Set thermostat knob to OFF position and then remove knob by lifting knob from shaft (see Figure 6).
- D. Loosen two screws from end of base plate and remove thermostat cover (see Figure 7).

WIRING

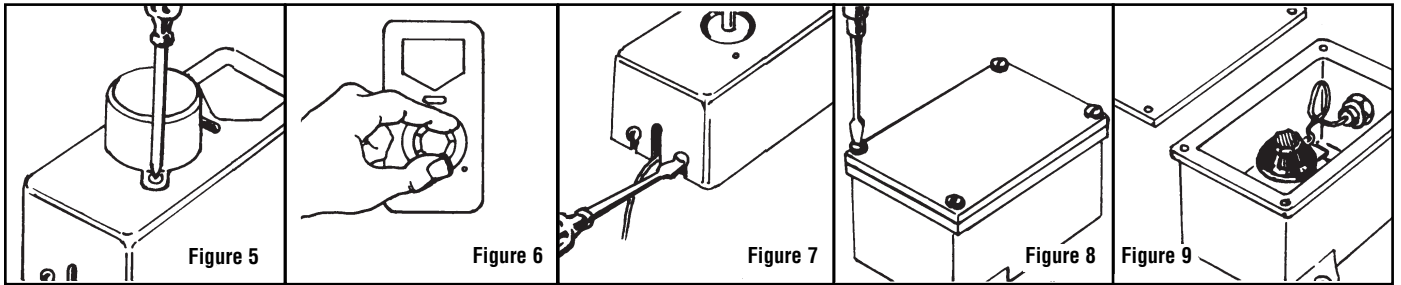

LT Models –

- A. Entrance for wiring is provided by two 3/4" NPT conduit holes in end of enclosure. Wiring to control enclosure should be in moisture-resistant conduit.
 - B. Remove cover by removing four hexhead screwbolts (see Figures 8 and 9).
2. Connect wires according to wiring diagrams (Figure 11 thru 15).

Note: Electrical connections should be made with generous loops of wire – approximately 6" per lead.

3. Replace cover and tighten screws.
4. Replace dial knob and dial knob cover. (NEMA-I models only).
5. **Note:** If load amperage or voltage rating exceeds switch rating, a contactor must be used (see Figure 14). Contactors are available as an optional part.

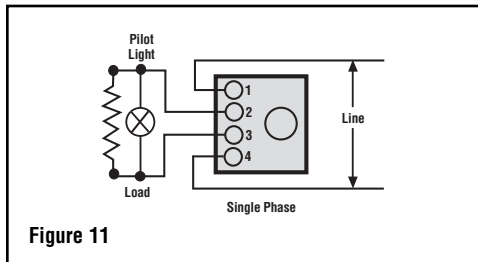

Figure 11

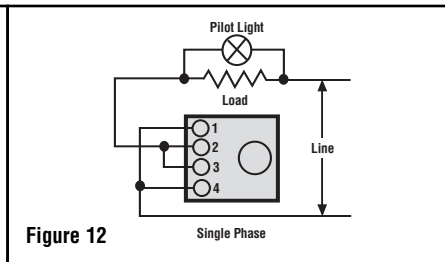

Figure 12

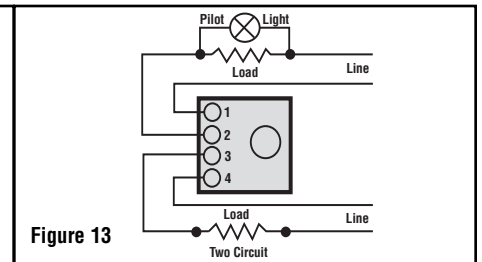

Figure 13

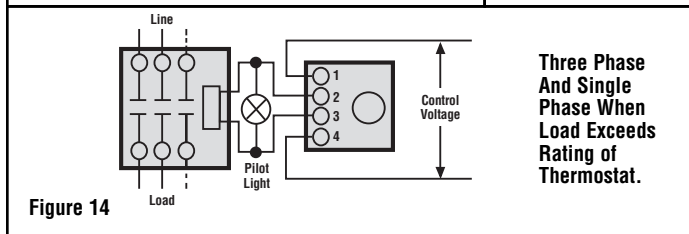

Figure 14

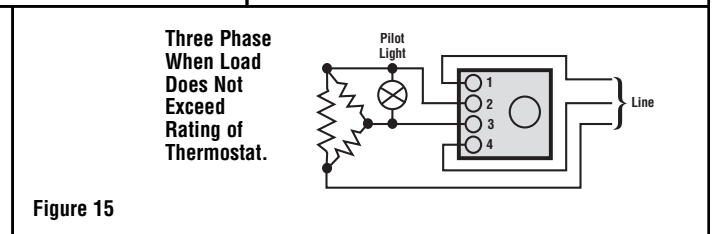

Figure 15

WIRING

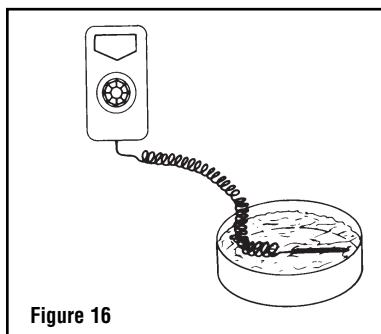

Figure 16

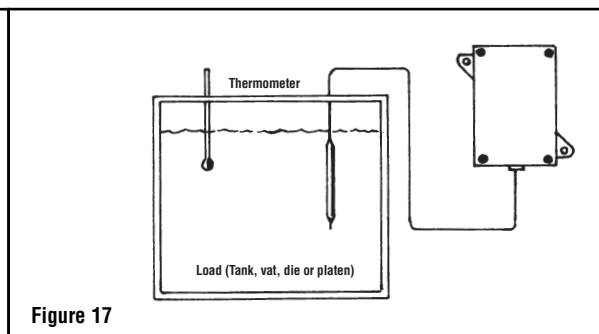

Figure 17

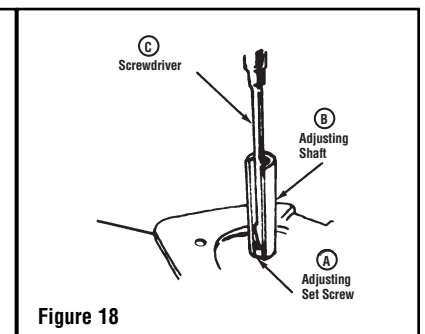

Figure 18

⚠ WARNING

ELECTRIC SHOCK HAZARD. Disconnect all power before attempting to calibrate thermostat. Failure to comply could result in personal injury.

These controls are factory calibrated to the range indicated on the control adjustment knob.

If calibration is required, either one of two methods may be followed:

- A. If accurate measurement standards are not available, the thermostat can be readily adjusted to a known temperature standard such as boiling water (212°F) (see Figure 16).
- B. With the aid of an accurate thermometer or other temperature measuring device, recalibration may be performed within the process as in Figure 17.

For either method, the following general calibration procedures should be followed:

1. Remove knob cover, knob and thermostat housing as per instructions 3, 4 and 5 under WIRING.

2. Replace knob and turn to highest temperature setting.
 3. Slowly turn knob and when controls click "off", compare the dial reading against the thermometer reading.
 4. **If they do not agree –**
 - A. Set dial knob to thermometer temperature reading and pull off knob.
 - B. While holding the adjusting shaft (B) tightly, turn small center adjusting screw (A) with small screwdriver (C) until thermostat clicks "off" (see Figure 18).
- Note:** Always use extreme care not to damage the slot in the center adjusting screw.
- C. Each quarter turn of the screw will change the calibration approximately 30°F:
 - Clockwise to decrease temperature
 - Counterclockwise to increase temperature
 - D. Recheck calibration and repeat process if closer calibration is required.

RENEWAL PARTS IDENTIFICATION

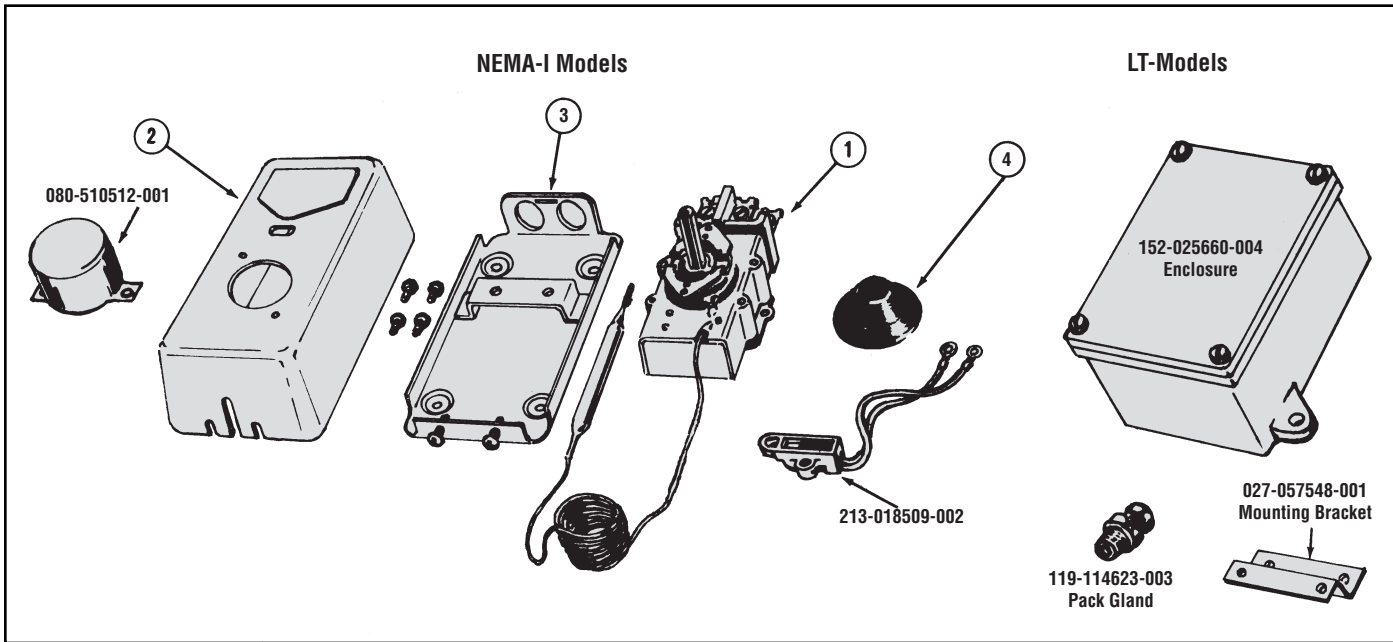

Model	① Thermostat Sub-Assembly	② Thermostat Cover	③ Thermostat Base	④ Knob
AR-115	300-048518-005	080-024763-001	015-013819-001	169-019605-002
AR-115A	300-048518-012	080-024763-001	015-013819-001	169-019605-002
AR-115C	300-048518-019	080-024763-001	015-013819-001	169-019605-002
AR-214	300-048518-001	080-024763-001	015-013819-001	169-019604-001
AR-214D	300-048518-026	080-024763-001	015-013819-001	169-019604-001
AR-215	300-048518-010	080-024763-001	015-013819-001	169-019604-001
AR-215A	300-048518-013	080-024763-001	015-013819-001	169-019604-001
AR-219	300-048518-002	080-024763-001	015-013819-001	169-019604-001
AR-219D	300-048518-022	080-024763-001	015-013819-001	169-019604-001
AR-514	300-048518-003	080-024763-001	015-013819-001	169-019604-002
AR-515	300-048518-011	080-024763-001	015-013819-001	169-019604-002
AR-515A	300-048518-014	080-024763-001	015-013819-001	169-019604-002
AR-519	300-048518-004	080-024763-001	015-013819-001	169-019604-002
AR-519D	300-048518-027	080-024763-001	015-013819-001	169-019604-002
AR-715	300-048518-006	080-024763-001	015-013819-001	169-019605-001
AR-715D	300-048518-029	080-024763-001	015-013819-001	169-019605-001
AR-719	300-048518-007	080-024763-001	015-013819-001	169-019605-001

Limited Warranty:

Please refer to the Chromalox limited warranty applicable to this product at <http://www.chromalox.com/customer-service/policies/termsofsale.aspx>.

Chromalox®
PRECISION HEAT AND CONTROL

1347 HEIL QUAKER BLVD., LAVERGNE, TN 37086
Phone: (615) 793-3900 www.chromalox.com