

Tubular Heaters Design & Installation Guidelines



Design Considerations

Sheath Material — For resisting corrosion inherent in the process or environment and for withstanding the sheath temperature required — Standard sheath materials are INCOLOY®, steel, copper and stainless steel (type 304). Other types of stainless steel, MONEL®, titanium and INCONEL® are available.

Job Requirements — The calculation of total heat requirements for an application is outlined in Technical section. For assistance, contact your Local Chromalox field sales engineer who will be glad to contribute his judgement, experience and knowledge in solving your heating problem.

After the specific heater size and rating has been tentatively selected, the watt density must be checked against the curves in Technical section.

If the heater selected has a watt density higher than stipulated by the curve, consider these alternatives:

1. Use more heaters of a lower watt density to obtain the required kW capacity.
2. Reduce the kW capacity needed by reducing heat losses and/or allowing for a longer heat-up time.

Watt Densities — The watt density of the element, or watts per square inch of element heated area, should be low for heating asphalt, molasses and other thick substances with low heat transferability. It can be higher for heating air, metals, liquids and other heat-conducting materials. See curves in Technical section for determining allowable watt densities.

When high operating temperatures are needed, watt density must be limited in order not to exceed the maximum sheath temperature. Watt density is given in the specifications for each tubular heater.

In general, a viscous material with low thermal conductivity requires a low watt density. Higher watt densities can be used with thinner liquids and with materials of high thermal conductivity. Premature loss of the element due to excessive temperature may result if the material's heat-take-away ability is low. Also, the material may be charred, carbonized or its chemical make-up altered by overheating.

Terminal Selection — Stocked tubulars are shipped with standard terminals, see Terminal Options in this section. Many other terminals and terminal end seals are available made to order.

CAUTION — Protect terminals from possible contamination from surrounding atmospheres such as oil fumes, chemical vapors from other processes, moisture, weather, etc. MgO insulation is hygroscopic.

Vacuums — Tubular heaters operate at higher temperatures in a vacuum because there is no air to take away the heat. Therefore, watt densities are recommended to be 20 to 30% lower. It is recommended terminals of the element be kept outside of the vacuum.

Code Compliance — Chromalox manufactures the highest quality heaters and controls and, where applicable, in compliance with such codes as the Canadian Standards Association (CSA), Underwriters Laboratories Inc. (UL) and Verification of Devices for Europe Testing and Certification Institute (VDE) and CE.

Installation Guidelines

Wiring — Must be in accordance with The National Electrical Code (NEC). It is important to use the correct wire gauge to carry the amperage required. A wire not large enough can overheat, become brittle and break. The ambient temperature must also be considered in choosing the correct type of wire and insulation. *Make sure wiring to terminals is tight. Keep terminals away from heat, if possible. (For higher temperatures, contact your Local Chromalox Sales office.)*

Mounting Methods — Elements can be supplied with threaded fittings for mounting thru walls of tanks, ovens, etc. Compression threaded fittings are also available for easy field installation. Rings, clips, brackets and washers can also be attached to elements for mounting purposes.

Easy Bending — To put heat where it is needed, tubular elements can be bent to fit most requirements. See following pages for customer bending and factory bending details. Bending should be done around a smooth round object such as a piece of pipe. For minimum bending radii, see Bending Guidelines.

Triangular Cross-Section

These unique cross-sectioned elements are specially designed for high element surface temperature applications, and wherever extreme rigidity is required.

Triangulation — A patented extra step by Chromalox to increase insulation density and maximize heat transfer and operating life. This method of compaction increases uniformity of resistance wire spacing to help eliminate hot and cold spots. It also increases the rigidity of the element, which is an advantage in some applications.

The terminal ends of these elements are re-rounded to facilitate the use of threaded fittings or other mounting methods.

The heart shaped cross-section is recommended for certain heavy duty applications. It has added structural strength, achieved through die pressing, which resists deformation or sagging when installed in the flow of high velocity air or thick oils and compounds, or in high surface temperature air heating.

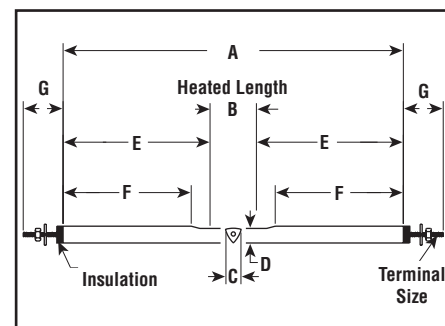

Sheath Material	Dimensions (In.)							Terminal Size
	A	B	C	D	E	F	G	
Copper	1	1	3/8	21/64	3-3/8	1-1/2	1±1/16	#10-32
Steel or INCOLOY®	1	1	3/8	21/64	3-3/8	1-1/2	1±1/16	#10-32
Copper, Steel or INCOLOY®	1	1	1/2	15/32	3-7/16	2-1/2	13/16±1/16	#8-32

1. See complete heater dimensions in table on product pages.

Tubular Heaters Modifications

World Leader in the Manufacture of Electric Heating Elements — Chromalox offers the most complete line of tubular heaters available. Standard diameters are:

Standard Diameters		Cross-Section Views
0.2 0.246 0.260 0.315 0.375 0.43 0.475	} Round	
3/8" 1/2"		} Triangular (heart shape)
3/8" 7/16"	} Flat Pressed	

Round Cross Section — Highly adaptable where elements must be bent — particularly if bending is performed in the field.

Triangular Cross Section — Patented process produces elements with the closest possible dimensional control.

Triangulated Cross Section — Flat pressed. Patented process provides large contact area for clamp-on applications. This means more efficient heat transfer, fewer elements since higher element ratings may be employed.

Voltage or Wattage — Heaters can be made for operation on any voltage and rated at any wattage suitable for the application within practical limits. For voltages higher than 480V, specify high voltage terminal construction. See Component section Tubular Heater (0.475 or 1/2" diameter only).

Special Wattage Distribution — Heaters can be made with higher wattages toward the end of the heated section to help offset losses in certain applications. Check with your Local Chromalox Sales office for additional information.

Tubing — Standard industrial grade wall thickness:

Repressed Bends — Tubulars can be bent to tighter radii at the factory. Bends are then repressed to ensure re-compaction of insulation for long life. Customer bending on larger radii does not require repressing. (See Factory Bending Guidelines in this section).

Sheath Length — Larger diameter heaters can be made in unspliced lengths up to 51 feet.

This eliminates the need for a spliced joint which is always a possible weak point that might cause premature heater failure.

Element Dia. (In.)	Max. Heater Length (Ft. ± 1%)
0.2	10
0.246	40
0.375	40
0.315	40
0.43	40
0.475	51
3/8	17±1/8"
1/2	17±1/8"

Note — Single-end elements have a maximum sheath length of 10 feet.

Terminal Construction — Many choices to suit your application. Tubular elements generally have a terminal for electrical connection at each end. Single end construction has both terminals at the same end.

UL and CSA — Chromalox tubular heaters can be furnished as UL Recognized and CSA Certified components with the addition of a terminal end seal. Terminal end seals can be added to stock elements and shipped in one week. (UL File E198480, Guide UBJY2, CSA File 40859). Use "end seal/moisture barrier" in place of end seal.

VDE and CE — Chromalox tubular heaters can be furnished as VDE Certified and CE certified. Contact your Local Chromalox Sales office.

Wide Choice of Sheath Materials — Available to meet a wide variety of applications. Standard sheath materials are: INCOLOY®, steel, type 304 and 316 stainless steel, copper, INCONEL® and MONEL®.

In addition, titanium and other 300 series stainless steel sheaths are available upon request. For applications requiring other materials, contact your Local Chromalox Sales office.

Cold Section — Longer cold ends can be supplied, as required, up to 20 inches. For longer cold ends, contact your Local Chromalox Sales office.

Factory Bending — Tighter bends can be made at the factory.

Tubular heaters can be formed to many different shapes to suit your application. This is done by specially designed bending tools and repressing dies for bending on many different radii.

Additional Features — Many additional features are available for the difficult jobs which require custom designed elements employing Chromalox's vast engineering experience.

Threaded Fittings

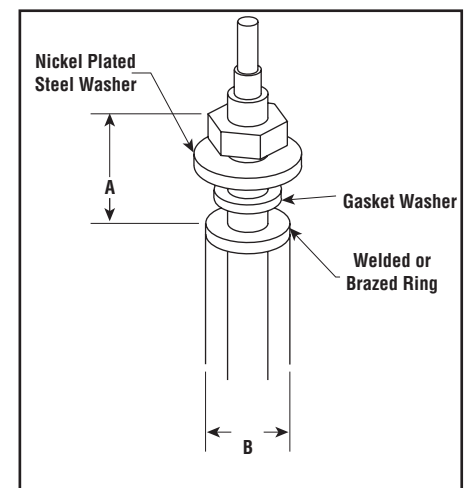

Element Dia. (In.)	Fitting Material	Mtg. Hole Dia. (In.)	Max. Wall Thickness (In.)	Thrd. Size F	Dimensions (In.)	
					A	B
0.246	Brass	13/32	7/32	3/8 - 24	15/32	7/8
0.315	Brass	15/32	5/16	7/16 - 28	13/16	7/8
3/8	Brass	17/32	5/16	1/2 - 28	13/16	7/8
1/2-0.475	Brass	21/32	5/16	5/8 - 24	13/16	1
0.246	Steel	13/32	7/32	3/8 - 24	15/32	7/8
0.315	Steel	15/32	5/16	7/16 - 28	13/16	7/8
3/8	Steel	17/32	5/16	1/2 - 28	13/16	7/8
1/2-0.475	Steel	21/32	5/16	5/8 - 24	13/16	1
0.246	Stainless Steel	13/32	7/32	3/8 - 24	15/32	7/8
0.315	Stainless Steel	15/32	5/16	7/16 - 28	13/16	7/8
3/8	Stainless Steel	17/32	5/16	1/2 - 28	13/16	7/8
1/2-0.475	Stainless Steel	21/32	5/16	5/8 - 24	13/16	1



Tubular Heaters

Factory Bending Guidelines

Note — OAL represents overall length.

Figure 1

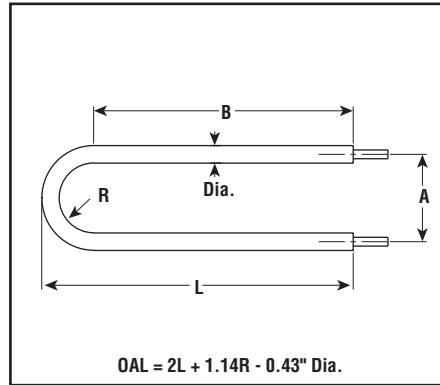

Figure 2

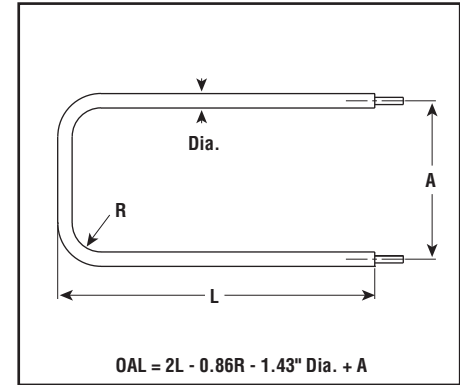

Figure 3

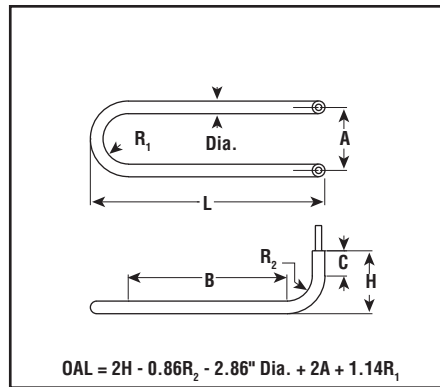
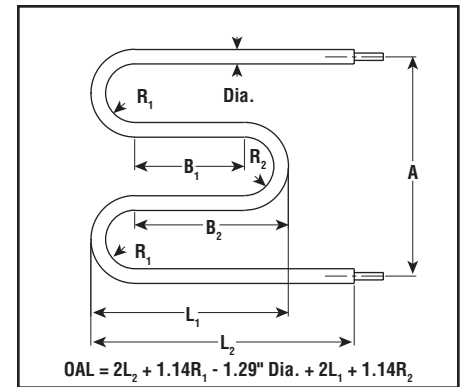

Figure 4



Factory Minimum Bends for Tubular Heaters

Element Dia. & Sheath	Inside $R_{1,2,3}$	Dimensions (In.) ¹				
		A	$B_{1,2}$	C	Inside D	E
▽ 1/2" INCOLOY® ⁵ Steel & Copper	3/4	1-3/8	1	1-1/2	5	8
	1/2	1-3/8	1	1-1/2	8	6
0.475" INCOLOY® Steel & Copper	3/4	1-3/8	1	1-1/2	3	8
	1/2	1-3/8	1	1-1/2	3	6
0.430" INCOLOY® Steel & Copper	7/16	1-3/8	1	1	3	8
	7/16	1-3/8	1	1	3	6
▽ 3/8" INCOLOY® ⁵ Steel & Copper	9/16	1-3/16	1	1-1/2	3-3/4	5
	3/8	1-3/16	1	1-1/2	6	3
0.375" INCOLOY® Steel & Copper	3/8	1-3/16	1	1	2-5/8	5
	3/8	1-3/16	1	1	2-5/8	3
0.315" INCOLOY® Steel & Copper	9/16	1-3/16	1	1-1/2	2	5
	5/16	1-3/16	1	1-1/2	2	3
0.260" INCOLOY® Steel & Copper	1/4	1-1/8	1	1	1-7/8	5
	1/4	1-1/8	1	1	1-7/8	3
0.245" INCOLOY® Steel & Copper	3/8	1-1/16	1	1-3/16	1-1/2	5
	1/4	1-1/16	1	1-3/16	1-1/2	3
0.200" INCOLOY®	1/4	1/4	1	3/4	1-1/4	5

To Order — Specify model, PCN, volts, watts, special features, if required, and quantity.

Specify for Factory Formed Tubulars:

- A. Figure number.
- B. A, $B_{1,2}$, C, D, E, H, J, K, $L_{1,2}$ and $R_{1,2,3}$ dimension as required.
- C. N - number of turns, Dia. - Element Diameter- aid < - angle as required.
- D. Material for threaded fittings.
- E. Special terminal type.
- F. Position of crown (flat side) of element (TC, TI, TS only).
- G. Submit sketch with special details.

Notes —

1. These are general guidelines only. Special dimensions and configurations are possible. Contact your Local Chromalox Sales office.
2. A dimension can be less if no fittings are required.
3. C dimension may need to be greater if special fittings are used.
4. E dimension is a minimum when R dimension is less than customer minimum bending radius.
5. Heart Shaped cross-section only.

Tubular Heaters

Factory Bending Guidelines (cont'd.)

Figure 5

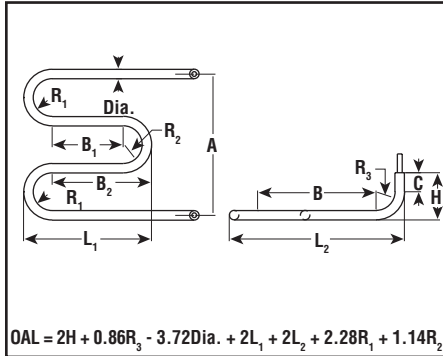

Figure 6

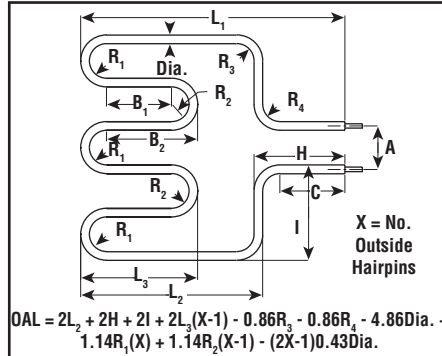

Figure 7

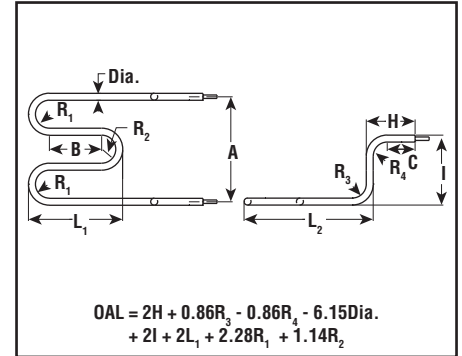

Figure 8

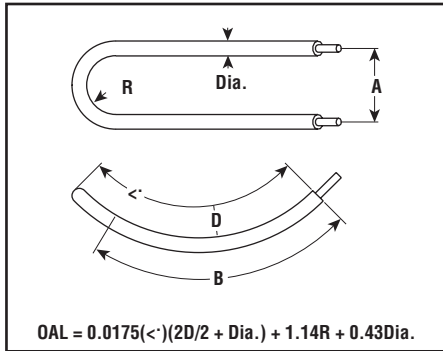

Figure 9

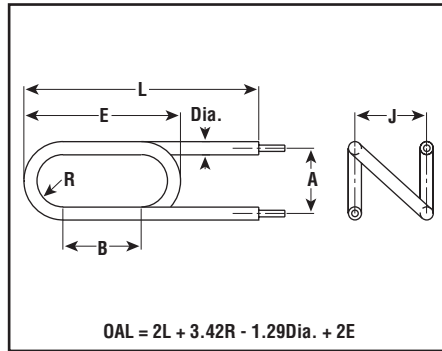

Figure 10

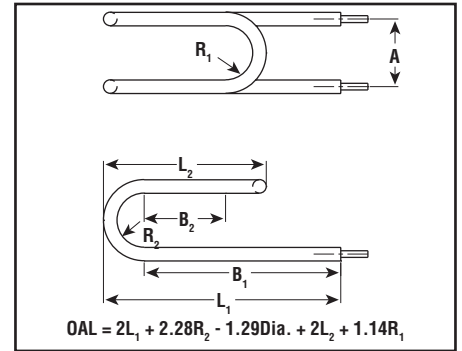

Figure 11

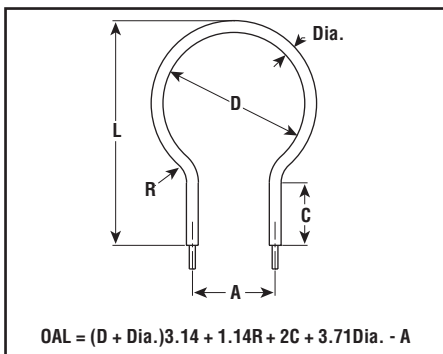

Figure 12

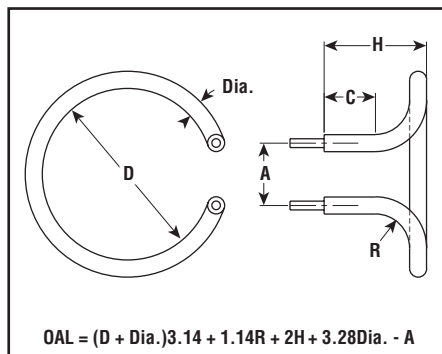

Figure 13

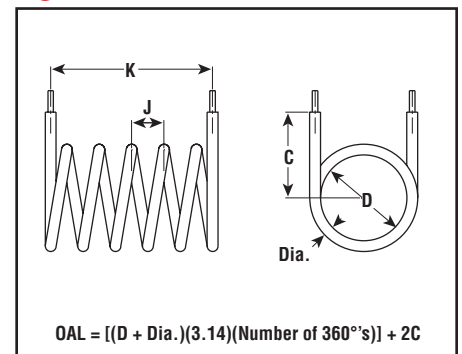

Figure 14

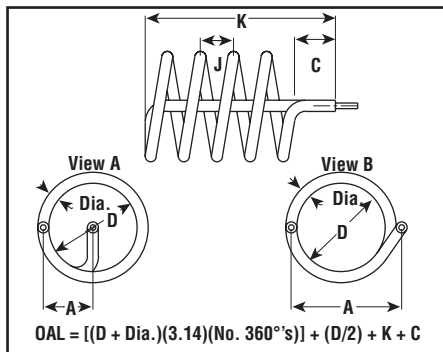

Figure 15

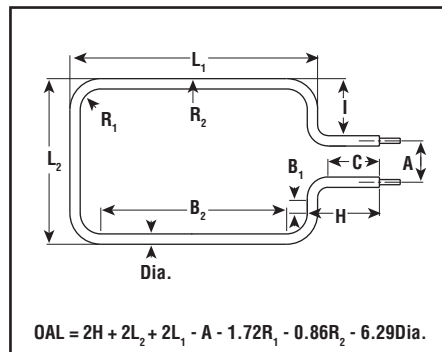
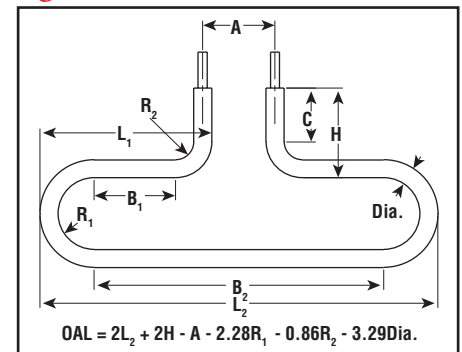

Figure 16



Tubular Heaters

Terminal Options

Standard, Alternate and Moisture Resistant Terminals

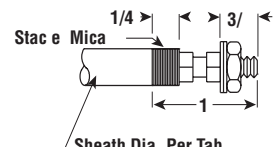
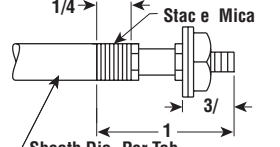
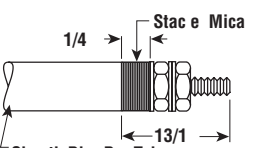
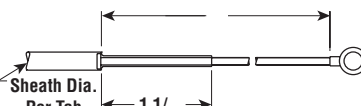
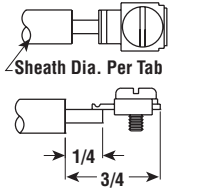
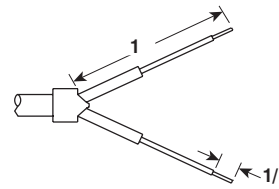
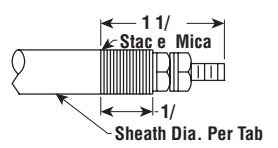
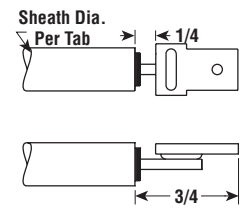
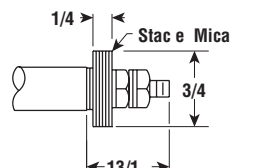
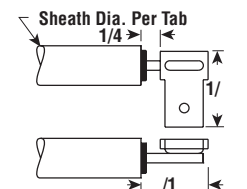
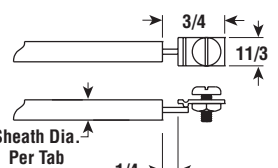
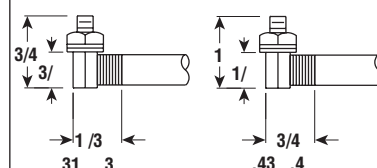
Type	Description	Sheath Dia. (In.)	Max. Volts	Type	Description	Sheath Dia. (In.)	Max. Volts
Standard Terminals							
3	 <p>Welded on threaded pin (#10-32), nut and washer</p>	0.315 0.375 0.43 0.475	480 480 480 480	28	 <p>Welded on threaded pin (#8-32), nut and washer</p>	0.246 0.25 0.26	240 240 240
4	 <p>Threaded terminal pin (#8-32), nut and washer</p>	0.43 0.475 0.5	480 480 480	34	 <p>Leadwire with sleeving, #6 Connector</p>	0.2	240
8	 <p>Terminal connector - 5/16" long, #10-32 machine screw</p>	0.246 0.25 0.26 0.315 0.375 0.43 0.475	240 240 240 240 240 240 240	STRI/STRS/STRC	 <p>Single-end tubular termination, 10" leadwire</p>	0.315 0.475	240 480
Alternate Terminals							
23	 <p>Threaded terminal pin (#8-32), nut and washer</p>	0.43 0.475 0.5	600 600 600	30	 <p>Ark-Les[®] Connector</p>	All	240
24	 <p>Threaded terminal pin (#8-32), nut and washer</p>	0.43 0.475 0.5	600 600 600	30R	 <p>Right-angle Ark-Les[®] Connector</p>	All	240
25	 <p>5/16" Long #10-32 Bolt with nut</p>	0.246 0.25 0.26 0.315 0.375 0.43 0.475	240 240 240 240 240 240 240	37	 <p>Extra mechanical strength #8-32 thread</p>	0.315 0.375 0.43 0.475	240 240 480 480

Tubular Heaters

Terminal Options *(cont'd.)*

Standard, Alternate and Moisture Resistant Terminals

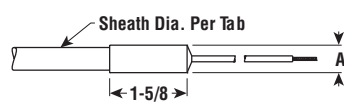
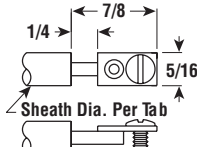
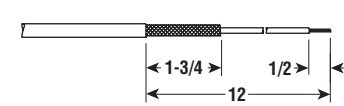
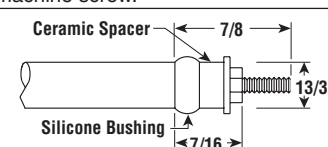
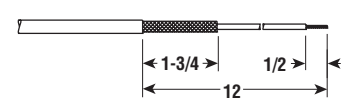
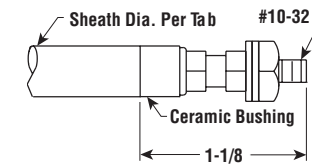
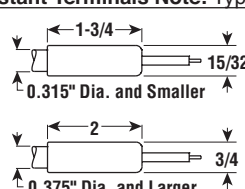
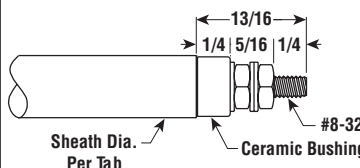
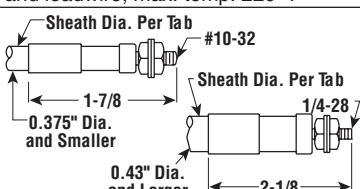
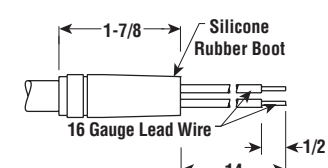
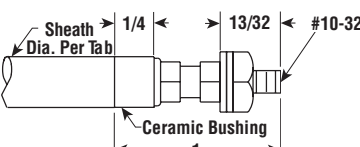
Type	Description	Sheath Dia. (In.)	Max. Volts	Type	Description	Sheath Dia. (In.)	Max. Volts								
Alternate Terminals <i>(cont'd.)</i>															
38	<table border="0"> <tr> <td style="text-align: center;">Dia. (In.)</td> <td style="text-align: center;">A</td> </tr> <tr> <td style="text-align: center;">0.315</td> <td style="text-align: center;">3/8</td> </tr> <tr> <td style="text-align: center;">0.375</td> <td style="text-align: center;">1/2</td> </tr> <tr> <td style="text-align: center;">0.43, 0.475</td> <td style="text-align: center;">9/16</td> </tr> </table>  <p>Leadwire type terminal</p>	Dia. (In.)	A	0.315	3/8	0.375	1/2	0.43, 0.475	9/16	0.315	480	48	 <p>Narrow profile terminal connector, 5/16" Long #10-32 or #8-32 machine screw.</p>	0.246	240
		Dia. (In.)	A												
0.315	3/8														
0.375	1/2														
0.43, 0.475	9/16														
0.375	480	0.25	240												
0.43	480	0.26	240	0.315	240	0.375	240								
0.475	480	0.43	240	0.43	240	0.475	240								
47-L	 <p>105°C leadwire, silicone sleeving</p>	0.315	480	49/50	 <p>Silicone bushing/ceramic disc seal, epoxy/RTV/silicone resin can be placed under bushing (type 49, #8-32 thread/ type 50, #10-32 thread)</p>	0.315	480								
		0.375	480			0.43	480								
		0.43	480			0.475	480								
		0.475	480			0.5	480								
47-M	 <p>200°C leadwire, silicone sleeving</p>	0.315	480	53	 <p>Air set cement, >700°F temp.</p>	0.315	480								
		0.375	480			0.375	480								
		0.43	480			0.43	480								
		0.475	480			0.475	480								
Moisture Resistant Terminals Note: Type 26 is the only Hermetic Seal, all others are Barriers.															
13	 <p>EPDM rubber vulcanized to sheath and leadwire, max. temp. 220° F</p>	0.246	240	39/40	 <p>Epoxy, 194°F max. temp., (type 39) RTV, 350°F max. temp., (type 40)</p>	0.43	480								
		0.25	240			0.475	480								
		0.26	240			0.5	480								
		0.315	300												
		0.375	480												
		0.43	480												
0.475	480														
0.5	550														
26	 <p>Hermetic seal, 1000°F max. element temp.</p>	0.315	240	42	 <p>Silicone rubber boot potted with RTV sealant, 0.475" dia. single-end only</p>	0.475	480								
		0.375	480												
		0.43	480												
		0.475	480												
		0.5	480												
39/40	 <p>Epoxy, 194°F max. temp., (type 39) RTV, 350°F max. temp., (type 40)</p>	0.315	480	V	V Seal (284°F) VP Seal Plus (392°F) A Seal (Sheath Limit) RX Seal (600°F) G Seal (1100°F)	0.26	480								
		0.375	480			to									
		0.43	480			0.475									

Tubular Heaters Customer Bending & Accessories

Brackets, Discs & Clips

Brackets, Discs and Clips — Various types of brackets and clips can be fastened to the heaters to facilitate installation. The following are typical.

For other brackets to meet your installation requirements, contact your Local Chromalox Sales office.

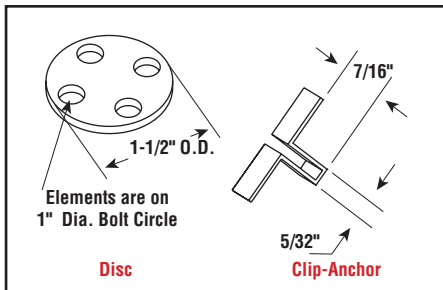
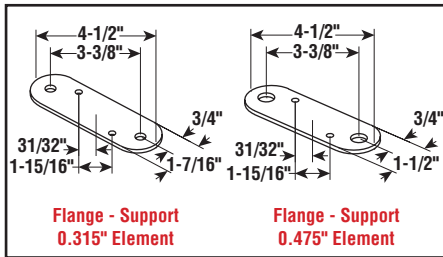

Compression Fittings

Field Installed Compression Fittings — For 0.475, 0.315 and 0.246" diameter elements. Available in both brass and steel, these fittings have been tested to 600 psi hydrostatic pressures and may be used in tank walls for liquid immersion as well as in air ducts and a variety of other applications.

Compression fittings do not require brazing and can be field mounted in minutes. They may be positioned anywhere along the cold section of the heating element. Do not position over heated section. Cannot be installed over terminal Type #26 (Hermetic Seal), and some other terminals wider than sheath diameter.

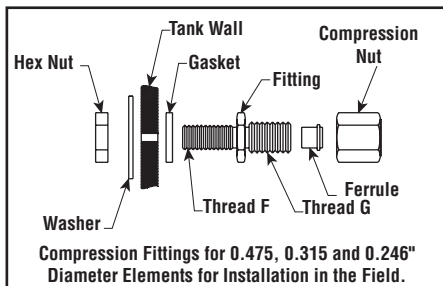

Customer Bending

Simple element configurations can be made easily in the field from stocked tubulars listed in this catalog. **If copper or stainless sheaths are selected, specify "To be fully annealed for bending."** Elements can be bent around any round, smooth surface of the right diameter.

Three precautions should be observed to prevent damage to the element:

1. Radius of the round object, around which the element is bent, should be no smaller than the minimum radius for the element, as shown in the table below.
2. Sharp edges of tools should not be permitted to gouge the element sheath while bending.
3. End of cold section of the element should not fall within the bend nor come within 1/4" of either side of the bend. To locate

end of cold section, see dimensions for the element on its catalog page and determine as follows:

Example — To locate end of cold section of TRI-1645 tubular element, refer to the individual product page.

Sheath length: 16"
Less heated length: 9-1/8"
Total cold length: 6-7/8"
Cold length of each end
(6-7/8" ÷ 2) = 3-7/16"

Terminal end bending can be done with pipe section of slightly larger diameter than sheath. A minimum 1" straight section should be left at the end. **Note** — To protect sheath, copper sheet can be bolted to vise jaws and end of pipe can be filed to remove sharp edge.

Before bending, it is best to lay out and dimension the configuration. Also, it is best to start bending from the center of the heater and work toward the terminal ends.

Sheath Material	Degree of Bend	Customer Bending — Min. Inside Radius (In.)								Not Std. Mat. in this Dia.
		1/2"	0.475"	0.430"	3/8"	0.375"	0.315"	0.26"	0.246"	
Copper	90	3-1/2	1-1/2	1-5/16	2-5/16	1-1/8	15/16	7/8	3/4	Not Std. Mat. in this Dia.
	180	3-1/2	1-1/2	1-5/16	2-5/16	1-1/8	15/16	7/8	3/4	
Steel	90	2-1/2	1-1/2	1-5/16	1-7/8	1-1/8	15/16	7/8	3/4	Not Std. Mat. in this Dia.
	180	2-1/2	1-1/2	1-5/16	1-7/8	1-1/8	15/16	7/8	3/4	
Alloy	90	2-1/2	1-1/2	1-5/16	1-7/8	1-1/8	15/16	7/8	3/4	5/8
	180	2-1/2	1-1/2	1-5/16	1-7/8	1-1/8	15/16	7/8	3/4	5/8

1. For radii smaller than shown, special processing is required to achieve good life qualities. Contact your Local Chromalox Sales office.

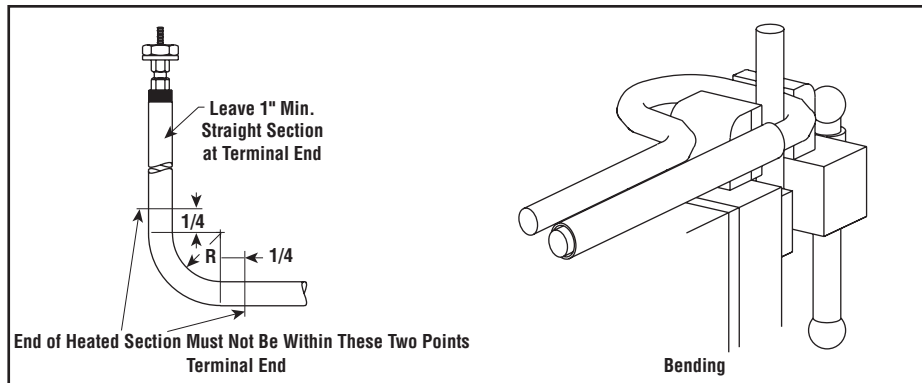

Material ¹	Dimensions (In.)				Thread Size		
	Elem. Dia.	Mtg. Hole Dia.	Max. Wall Thickness	Assembled Overall Length	F	G	PCN
Brass	0.246	13/32	7/32	1-7/16	3/8-24	1/2-24	144151
Brass	0.315	15/32	5/16	1-1/2	7/16-28	1/2-24	144143
Brass	0.475	21/32	5/16	2	5/8-24	3/4-24	144135
Steel	0.246	13/32	7/32	1-3/4	3/8-24	1/2-24	143474
Steel	0.315	15/32	5/16	1-3/4	7/16-28	1/2-24	143466
Steel	0.475	21/32	5/16	2-1/8	5/8-24	3/4-24	143458

To Order — Specify PCN, material, element diameter and quantity. Available in pairs only.

1. Available only in brass and steel at this time.