

Strip & Ring Heaters

Applications & Features



- Up to 72" Lengths
- Up to 3,000 Watts
- 120 - 480 Volt
- Up to 38 W/in²
- Maximum Sheath Temp.
 - Rust-Resisting Iron 750°F
 - MONEL® 900°F
 - Chrome Steel 1200°F
 - INCOLOY® 1500°F
- Accessory Clamping Devices, Optional

High Quality, Coiled Alloy Resistor Wire is uniformly spaced over the width and length of the strip heater to assure even heat distribution.

Resistor Wire is Embedded in specially formulated, high-grade refractory material which both insulates the resistor and transfers heat rapidly to the sheath.

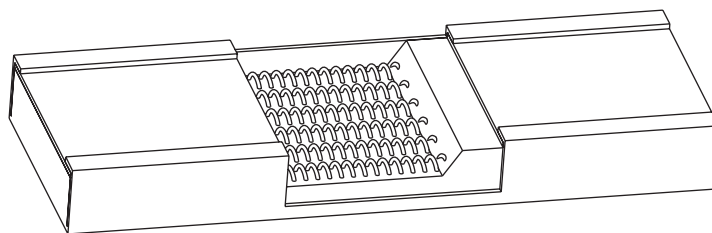

Refractory is then Compressed to Rock-Hardness and high density under tremendous hydraulic pressure to maximize heat transfer from coil to sheath. Elements are oven cured at high temperatures to semi-vitrify and mature the refractory.

Maximum Heat Transfer, from the instant the element is first energized, is provided by the high emissivity black oxide finish. Elements with shiny surfaces do not transfer heat as well.

Applications

Chromalox strip heaters are used principally for convection-type air heating and clamp-on installations. When selecting strip heaters for either, two important factors must be considered:

1. The proper sheath material for resisting any rusting and oxidizing inherent in the process or environment and for withstanding the sheath temperature required. Standard sheath materials are rust-resisting iron, chrome steel and INCOLOY® (type NS only). Stainless Steel and MONEL® sheaths are available.
2. The watt density of the element, or watts per square inch of heated area, should be low for heating asphalt, molasses and other thick substances with low heat transferability. It can be higher for heating air, metals and other heat-conducting materials. (See Technical section for determining allowable watt densities.)

When high operating temperatures are needed, watt density must be limited in order not to exceed the maximum sheath temperature. Watt density is given in the table for each strip heater.

In general, a viscous material with low thermal conductivity requires a low watt density. High watt densities can be used with thinner liquids and with materials of high thermal conductivity. Premature loss of the element due to excessive temperature may result if the material's heat-take-away ability is low. Also, the material may be charred, carbonized or its chemical makeup altered by overheating.

Features

Choice of Sheath Materials capable of operating up to 1500°F sheath temperature to heat various processes economically. These include rust-resisting iron (750°F), chrome steel (1200°F), Monel® (900°F), and INCOLOY® (1500°F).

Refractory Insulated Construction exclusively. By far the most rugged and best for long, dependable service.

More Types and Ratings — More precise matching to your power service and work load requirements. Special ratings and sizes can be manufactured readily.

More Stocked Models — Hundreds of models in stock and available for immediate shipment.

Lengthwise and Cross Section Curving

— Available only on made-to-order products for efficient heat transfer. Strip and ring heaters can be factory formed to fit the shape of the surface to be heated.

Easy Installation — Chromalox clamping devices and mounting tabs speed installation.

More Choices of Strip Heater Terminal Locations — To simplify wiring layout between elements and power lines.

Many Additional Features — Available to adapt heaters to suit special applications — made-to-order.

Installations — Minimum maintenance costs.

Controls are Part of the Total Chromalox Package for your heating job, regardless of its type or the temperature precision you need. Refer to the Controls section.



Strip & Ring Heaters

Selection & Installation Guidelines

- Utility Clamps
- Milled Plates
- Clamping Bands
- Oven Mounting

Installation Guidelines

Chromalox strip elements, in most cases, can be applied with standard hardware. However, for firm contact and best heat transfer, stocked Chromalox clamps are recommended.

Note — Heat insulating material should not be placed against the sheath of the heating element

Utility Clamps

Utility Clamps secure strip elements to flat surfaces or surfaces with large radii such as large tanks. Threaded studs are welded to surface, heaters are positioned, then clamps are bolted down. Where more than one clamp is used, tighten nuts and then back off 1/2 turn to allow for expansion.

Utility Clamps

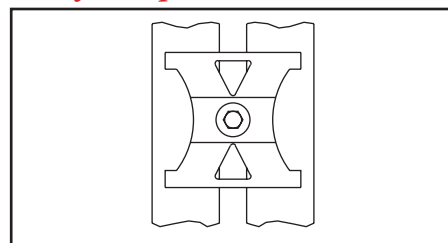

Milled Plates

Milled Plates allow heaters to be held in position in platens and similar objects with a steel plate recessed to heaters width, thickness and positions, then screwed to the working plate or surface.

Milled Plates

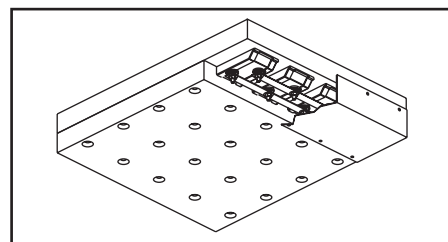

Clamping Bands

Clamping Bands can be used to firmly fasten strips longitudinally to large diameter cylindrical surfaces.

Connecting Lead Wires — Should be nickel-plated copper, nickel or alloy. Copper will oxidize and loosen connections. Do not use copper terminal lugs. See Accessories in this section.

Clamping Bands

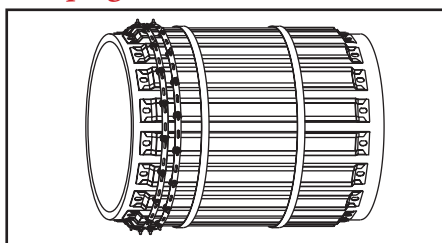

Selection Guidelines

Oven Mounting

Oven Mounting — Application of strip elements to ovens may be made simply with the use of welded-on studs and secondary insulation bushings. Mounting holes in tabs are slotted to allow for expansion. Refer to Modifications in this section.

Oven Mounting

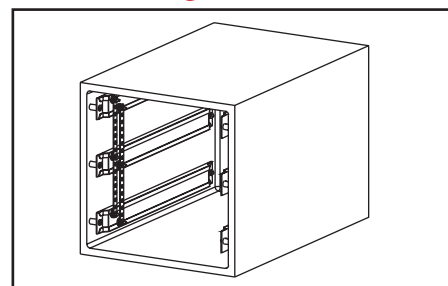

Product to be Heated	Temperature Desired for Products	Sheath Material	Product Temp. (°F)	Allowable Watt Density (W/In ²)		
Solids						
Molds, Platens, Dies, Pipes, Tanks	Up to 1400°F Clamp-On Applications	Rust-Resisting Iron	560	3		
			150	8		
			Chrome Steel	850	7	
					700	10
					400	15
		INCOLOY® ¹	200	28		
			750	20		
			1100	8		
			1350	3		
			1400	2.5		
Air & Gases						
Free Air Velocity- 1 ft/sec.	Up to 1400°F Bracket Mounted	Rust-Resisting Iron	500	3		
			100	8		
			Chrome Steel	950	7	
					800	10
					500	15
		INCOLOY® ¹	1400	3		
			400	34		
			Free Air Velocity- 4 ft/sec.	Up to 1400°F Bracket Mounted	Rust-Resisting Iron	500
						250
Chrome Steel	1000	7				
			850		10	
			550		15	
INCOLOY® ¹	1400	5				
	600	34				

Note: ¹CSA Only

Strip & Ring Heaters

Modifications

Lengthwise Bending

Lengthwise Bending for clamping around pipes or cylindrical vessels. Terminals may be located inside or outside of curvature for all types listed.

3" Min. Inside Radius — Type S, SE, OT PT, TH, NH, SNH, SN and ST.

6" Min. Inside Radius — Type SSE, SSEM, SSNH and SSNHM.

4-3/4" Min. Inside Radius — Type WS.

Lengthwise Bending

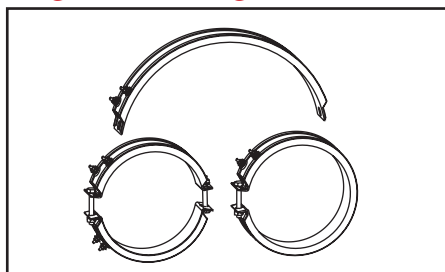

Cross-Section Curving

Cross-Section Curving — Type SE only, for clamping strips to 2, 2-1/2, 3, 4, 6, 8 and 12" pipes. For larger size pipe, use flat strips. Radii available 1-3/16, 1-7/16, 1-3/4, 2-1/4, 3-5/16, 4-5/16 and 6-5/16" and 8-3/4". Terminals outside only.

Cross-Section Curving

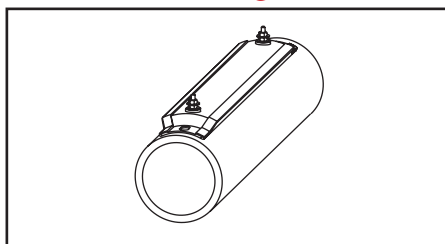

Special Lengths — Type PT, SE, SN and SNH only. Special lengths are made-to-order for instances in which the amount of heat applied to a surface is critical and standard lengths are not suitable.

Special Voltage and Wattage — All types. Certain highly specialized applications may require special ratings. However, most can be handled with standard heaters or standard ratings applied on an alternate voltage. Contact your Local Chromalox Sales office.

Special Wattage Distribution — All types except TH. When even temperatures are required and end losses may cause an unsatisfactory temperature drop near the edges, additional wattage can be provided at each end of the strip to make up for losses.

Dual Contact Surface — Type SE only. 53-7/8" maximum A dimension. Flush-top construction gives good contact for all surfaces of the strip heater. Ideal for use in machined slots and installing between two smooth metal surfaces.

Without Mounting Tabs

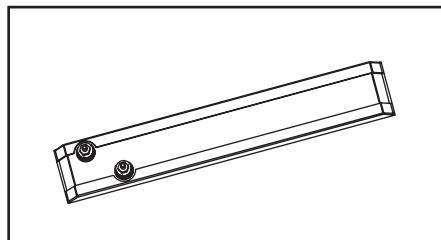

Without Mounting Tabs — All types. Permits installing more heat in a given confined space. Specify "without mounting tabs" when ordering this feature.

Extra Strong Mounting Tabs — All types except WS. Recommended when strips are bent lengthwise and tabs are used for bolting.

Monel® Sheath — Type S, SE, OT, PT, HSP and WS.

Stainless Steel Sheath — All types.

Cover for Seamless Strips, Factory Welded

Cover for Seamless Strips with Threaded Opening for Conduit — Cover is welded to heater. Specify position of threaded opening either on top of cover, or as shown. Type SSE, SSEM and SSNHM.

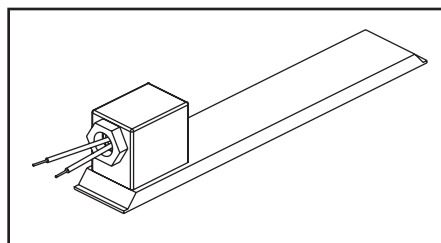

Fahnestock® Terminals

Fahnestock® Terminals — Type S only. For quick temporary connections where ambient temperatures do not exceed 150°C. Maximum recommended amperage is 7.5 Amps.

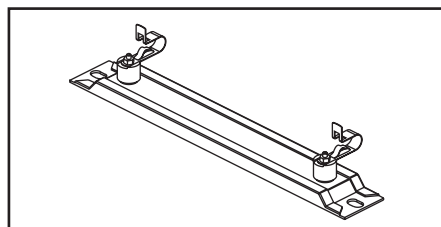

Special Length Terminals — All types. Where a shorter or longer terminal bolt than standard shown in drawing is needed, indicate length needed.

Rubber-Molded Terminals

Rubber-Molded Terminals — Type NS only. Used generally in low temperature applications where moisture, condensation and high humidity are considerations. Available in neoprene-rubber (to 190°F). Longer cold end or lower wattage is required to assure temperature limit of molding material is not exceeded. End opposite terminal is welded closed.

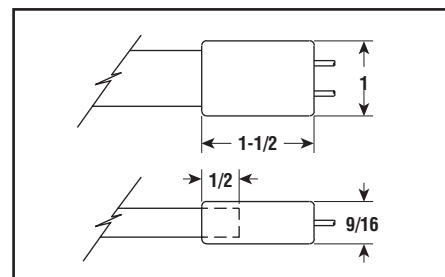

Special Lead Wire Terminal Construction

Special Lead Wire Terminal Construction — All types. Specified most often when clearance is unavailable for standard terminals and when lead wires are more suitable for wiring to nearby components.

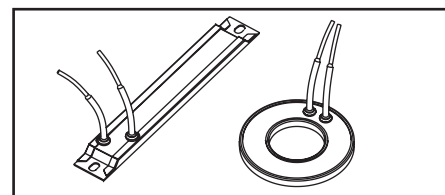

Secondary Insulation Bushing

Secondary Insulation Bushings — All Types except NS. Must be used when strips are mounted for air heating only or when connected in series on line voltages 480V or above. **Note** — To accommodate bushings, a 17/32 x 11/16" diameter mounting hole in tabs should be specified for heaters. To Order — Specify PCN 255716 (includes bushing and hardware for one strip) and quantity.

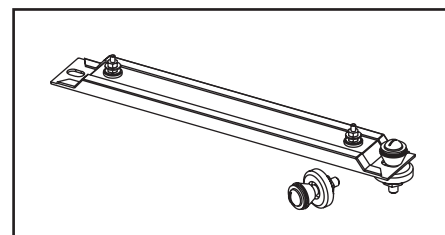

Strip & Ring Heaters

Accessories

- Protective Terminal Covers
- Shims
- Ceramic Post Terminal Insulators
- Porcelain Hi-Temp Insulation

Protective Terminal Covers — Types OT, PT, SE, WS and Seamless Types SSE, SSEM, SSNH and SSNHM. Helps guard terminals from spillovers, dripping. Removable sheet-metal cover, with Bx fitting, is shipped separately.

OT-AC-1 (PCN 129242)

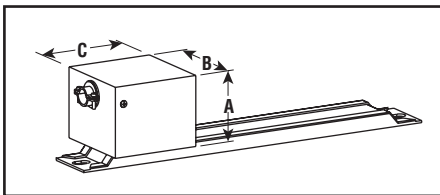

PT-AC-1 (PCN 255724)

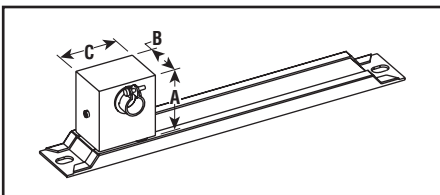

SE-AC-1 (PCN 256727)

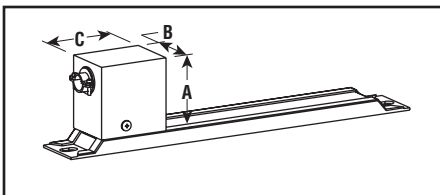

Protective Terminal Covers

Model	Dimensions (In.)		
	A	B	C
OT-AC-1	2	2-1/2	2-1/2
PT-AC-1	1-7/8	1-1/8	1-3/4
SE-AC-1 ¹	2-1/16	1-1/2	2

1. Used on type WS (mounted sideways).

Shims

Shims — Types OT, PT, S, SE and TH. Provide same advantage as flush-top construction and can be used with stock heaters. Shims are 0.031" thick, 29/32" wide and lengths to fit heater.

Shims

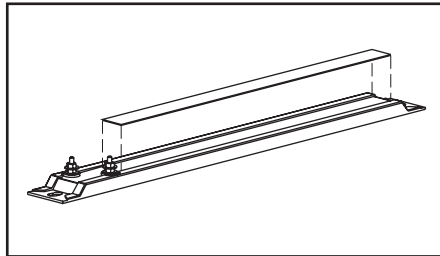

Ceramic Post Terminal Insulators

Ceramic Post Terminal Insulators — All types except NS and SN. Use with insulated wire to help protect against electrical shock. Wires can leave terminal at any angle.

Ceramic Post Terminal Insulators

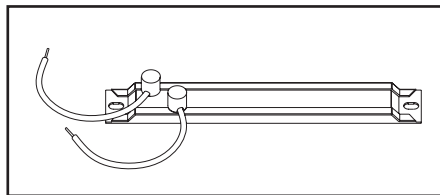

PCN 259805 (Nickel plated steel hardware)
PCN 255732 (Stainless steel hardware)

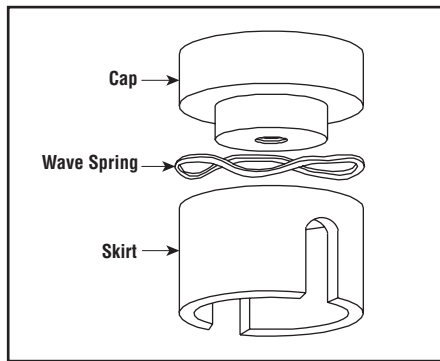

Porcelain Beads

Bead Size	Dimensions (In.)			Wire Size Solid	No. Beads Per Ft.	No. Beads (Pieces)	PCN
	A	B	C				
2	0.17	0.068	0.17	14 B&S	88	4,535	263880
3	0.2	0.092	0.2	12 B&S	69	2,900	263900
4	0.26	0.156	0.26	8 B&S	51	1,500	263927
5	0.33	0.124	0.33	10 B&S	45	650	263943
6	0.4	0.156	0.4	8 B&S	38	360	263960

To Order—Specify PCN and quantity.

Porcelain Hi-Temp Insulation

Porcelain Hi-Temp Insulation — For insulating buss bars spec. 51 porcelain insulators 1/2 L x 13/16" W with 1/8 x 9/16" slot. 95 pieces per lb.

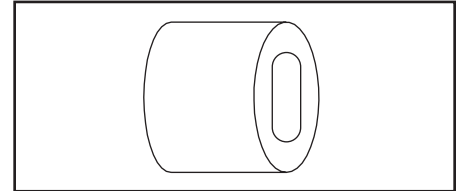

To Order — Specify pounds, PCN 269780 and porcelain insulators.

For Insulating Bare Wires — Two types available:

1. **Porcelain Tubing** — 3/8" O.D. x 1/8" I.D. x 6" L (may be broken for shorter lengths). Suitable for 10-gauge or smaller; 8-gauge takes No. 6 porcelain bead.

To Order — Specify quantity and PCN 263863.

Porcelain Tubing

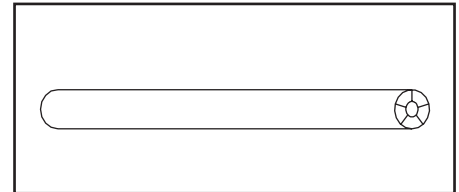

2. **Porcelain Beads** — Listed in table below. Can be used when wiring does not permit straight tubing.

Porcelain Beads

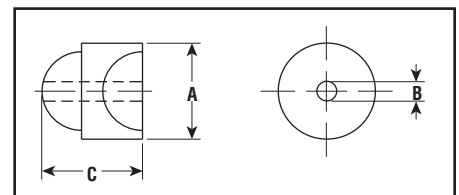

3. When selecting porcelain beads for stranded wire, use next larger gauge wire and use bead for that size (i.e., 10 gauge stranded wire requires a No. 6 bead).

Strip & Ring Heaters

Wire & Accessories

(cont'd.)

- High Temperature (Bare) Wire
- Insulated Wire
- Buss Bar
- Silicone Boot Termination Kit
- Silicone Boot Termination Kit with Thermostat

Ambient Temperature Corrections for Insulated Wires — Multiply ampacity values, in tables below, by the following correction factors to determine current-carrying capacity at higher ambient temperatures.

Ambient Temp.		Nickel-Plated Copper Teflon® Insulated	Nickel		MGS-Mica Glass
°C	°F		Silicone Glass	Teflon® Glass	
30	86	—	—	—	1.36
50	122	0.98	0.97	0.98	—
60	140	0.95	0.94	0.95	—
70	158	0.93	0.9	0.93	—
80	176	0.9	0.87	0.9	—
90	194	0.87	0.83	0.87	—
100	212	0.85	0.79	0.85	1.22
120	248	0.79	0.71	0.79	—
140	284	0.72	0.61	0.72	—
149	300	0.65	0.5	0.65	1.12
177	350	0.58	0.35	0.58	—
204	400	0.49	—	0.49	1
232	450	0.35	—	0.35	—
260	500	—	—	—	0.87
269	550	—	—	—	—
300	572	—	—	—	0.7

Note — After exposure to high temperatures, all wire insulation becomes brittle and will not withstand repeated flexing.

Wire & Buss Bar

High-temperature wire and buss bar are recommended for connections to heater terminals and for runs in heated zones. When ambient temperature exceeds maximum allowed for insulated wire, use bare wire or buss bar with porcelain insulators. Current-carrying capacities should be carefully noted.

Buss bar is solid or perforated to facilitate wiring, especially when terminals are in line. Perforated buss bar, has 11/32 x 7/32" slots on 7/16" centers. When connecting elements with buss bar, provide expansion loops between elements. Buss bars may be used in multiples for higher ampacity (approx. 33-1/2% per buss bar) than listed above, center.

High Temperature (Bare) Wire

Size AWG	Solid/S Strand/F	Ampacity ¹	Nom. O.D.	Model	PCN
550°F Max. Wire Temp. Nickel-plated Copper, Uninsulated					
14	S	41	.064	CSB-14	263839
10	S	70	.102	CSB-10	263812
8	S	93	.128	CSB-8	263804
1000°F Max. Wire Temp. Manganese-Nickel, Uninsulated					
14	F	12	.075	AFB-14	269317
14	S	12	.064	ASB-14	269309
12	F	15	.097	AFB-12	269296
12	S	15	.081	ASB-12	269288
10	S	20	.102	ASB-10	269261

To Order — Specify PCN and quantity.

Insulated Wire

Size AWG	Solid/S Strand/F	Ampacity ¹	Nom. O.D. Insul. In.	Model	PCN
392°F Max. Wire Temp. Type A Nickel Wire Silicone Rubber Treated Glass Braid Insulated 600V UL Listed					
16	F	27	.224	3-CFI-16	263759
16	S	27	.224	3-CSI-16	263740
14	F	36	.237	3-CFI-14	263732
14	S	36	.237	3-CSI-14	263724
12	F	45	.263	3-CFI-12	263716
12	S	45	.263	3-CSI-12	263708
10	F	60	.29	3-CFI-10	263695
10	S	60	.29	3-CSI-10	263687
482°F Max. Wire Temp. Type TGT, Nickel-plated Copper, Teflon® Impregnated Glass Braid Insulated 600V UL Listed					
14	F	39	.121	6-CFI-14	263791
14	S	39	.112	6-CSI-14	295398
12	F	54	.141	6-CFI-12	263783
12	S	54	.13	6-CSI-12	295400
10	F	73	.17	6-CFI-10	263775
10	S	73	.156	6-CSI-10	295419
8	F	93	.212	6-CFI-8	263767
482°F Max. Wire Temp. Teflon® Tape and Silicone Impregnated Glass Braid Insulated 600V UL Listed					
14	F	39	.121	3-AFI-14	269253
12	F	54	.141	3-AFI-12	269237
10	F	73	.17	3-AFI-10	269210
842°F Max. Wire Temp. Nickel-clad Copper, MGS-Mica Glass Insulated 600V					
16	F	33'	.065	6-CFIM-16	295355
14	F	44'	.102	6-CFIM-14	295363
12	F	55'	.118	6-CFIM-12	295371

To Order — Specify PCN and quantity.
 1. See note 1 in Buss Bar Table.
 2. These wiring recommendations are general in nature. Confirm actual wire size and selection in accordance with NEC (National Electrical Code).

Buss Bar

Buss Bar Model	DIM (In.)		Ampacity ¹	PCN
	Width	Thick		
700°F Max. Wire Temp.				
Solid				
	0.5	.032	18	346124
	0.5	.064	28	346132
Perforated Slot Size = 7/32 Dia.				
	0.5	.032	9	346140
	0.5	.064	16	346159

To Order — Specify PCN and number of feet.
 1. These current values will cause the conductor to operate at 100°F above surrounding ambient. Values may also be used for bare wire with porcelain tubes or bead insulation. Model max. limit is 800°F.



Silicone Boot Termination Kit

SBK — The silicone boot termination kit provides electrical insulation for strip heater terminals and leads with ring type insulated connector on one end for bringing power to the strip heaters.

Silicone Boot Termination Kit with Thermostat

SBKT — The silicone boot termination kit with thermostat used with strip heaters provides an inexpensive way to maintain temperature in control cabinets, panels and other small enclosures. In this application, strip heaters are used to prevent freezing and corrosion, and to control humidity in enclosures with humidity sensitive electronic components.

Model	PCN	Temperature (°F)	
		Closes	Opens
SBKT-1	386011	38	53
SBKT-2	386020	60	75
SBKT-3	386038	105	120
SBK	121890	N/A	N/A

SBKT

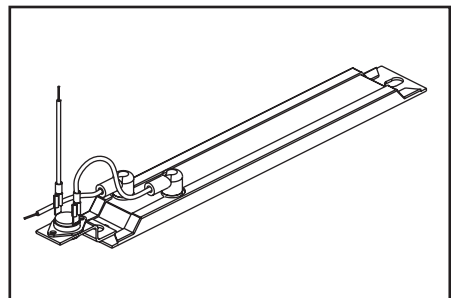

Strip & Ring Heaters

Accessories (cont'd.)

- Element Clamps
- Mounting Studs

Element Clamps

Cast-iron clamps, for use with Chromalox strip and ring elements, retain their strength at elevated temperatures to assure maximum sheath-to-surface contact. Resulting uniform efficient heat transfer from internal resistance wire to the heated material minimize hot spots on the element, contributing to long service life.

Clamp 6018 — Usually used in sets of two or more to clamp ring elements to flat surfaces. 5/16" flathead machine screws are normally used with head brazed or welded to work surface (PCN 263978).

Clamp 6018

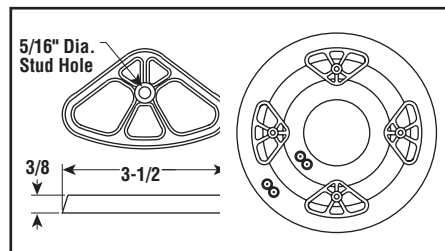

Clamp 5971 — Use to clamp two strip heaters on 2" centers using 5/16" studs spaced 5" apart (PCN 263636).

Clamp 5971

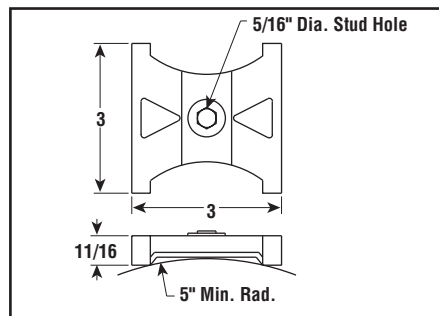

Clamp 5970 — Use to clamp three strip heaters on 2" centers using 5/16" studs at 5" intervals (PCN 263652).

Clamp 5970

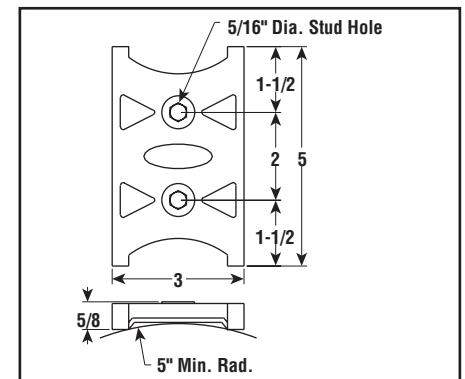

Clamp 6933 — Use to clamp two strip heaters on 3" centers using 3/8" studs at 5" intervals (PCN 263644).

Clamp 6933

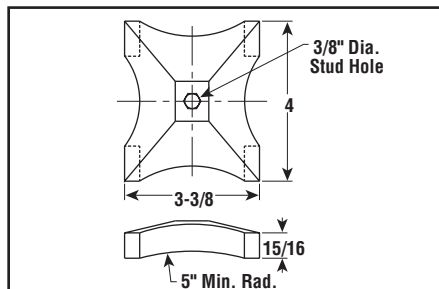

Mounting Studs

Mounting Studs — For use with Chromalox clamps. For all clamps except No. 6933, studs are 5/16" — 18 x 1-1/2" Monel® (PCN 127845), steel washer (PCN 127853), Monel® nut (PCN 127861). For No. 6933 clamp; studs are 5/16" — 18 x 2" Monel® (PCN 127837).

Installation — Fasten studs to the work surface by welding, brazing or threading. Use correct size stud to fit clamp. See Selection & Installation Guidelines in the Components section. For temperatures over 750°F, stainless steel studs are recommended.

Note — When tightening nuts, torsion should not exceed 10 foot pounds maximum. Heaters must be allowed to expand. One center clamp should hold heater. Nuts on other clamps should be backed off approximately 1/2 turn to allow for heater expansion.